

# СОДЕРЖАНИЕ

|   |    |
|---|----|
| ДОСКА ОБЛИЦОВОЧНАЯ (вагонка) .....            | 2  |
| ДОСКА ПОЛА .....                              | 3  |
| НАЛИЧНИК .....                                | 4  |
| ПЛИНТУС .....                                 | 8  |
| КОРОБКА ДВЕРНАЯ .....                         | 15 |
| ШТАПИКИ .....                                 | 16 |
| КАРНИЗ .....                                  | 18 |
| ПОРУЧЕНЬ .....                                | 19 |
| УГОЛОК .....                                  | 20 |
| БЛОК ХАУЗ .....                               | 21 |
| КОНСТРУКЦИОННЫЙ БРУС .....                    | 22 |
| ОБЛИЦОВОЧНАЯ ЦИЛИНДРИЧЕСКАЯ ПОВЕРХНОСТЬ ..... | 24 |
| ТЕРРАСНЫЕ ДОСКИ .....                         | 27 |
| ПОТОЛОЧНЫЕ БАЛКИ ДЛЯ ОПАЛУБКИ.....            | 28 |

# ДОСКА ОБЛИЦОВОЧНАЯ (вагонка)

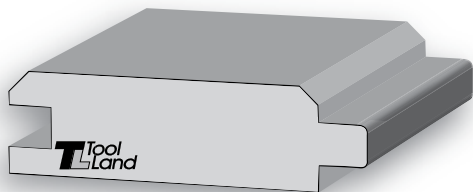

**М 1:1,5**

**ДО-1**

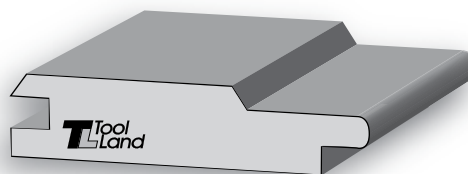

**М 1:1,5**

**ДО-2**

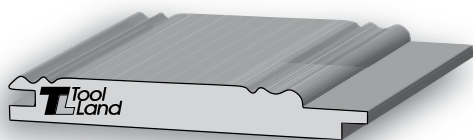

**М 1:2**

**ДО-3**



**М 1:1,5**

**ДО-4**

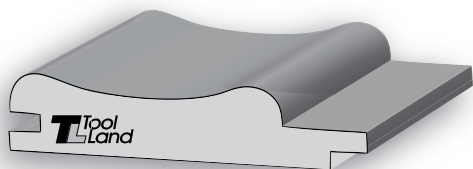

**М 1:1,5**

**ДО-5**

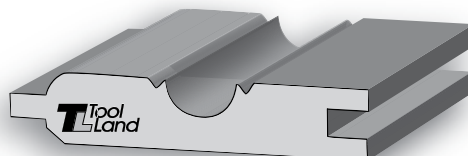

**М 1:1,5**

**ДО-6**

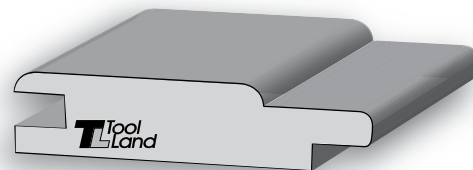

**М 1:1,5**

**ДО-7**

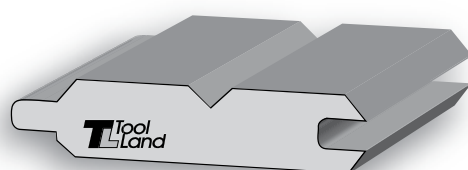

**М 1:1,5**

**ДО-8**

# ДОСКА ПОЛА



**M 1:5**

**ДП-1**

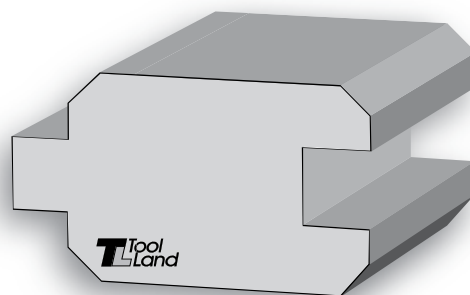

**M 1:2**

**ДП-2**

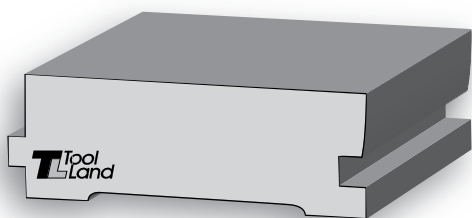

**M 1:2**

**ДП-3**

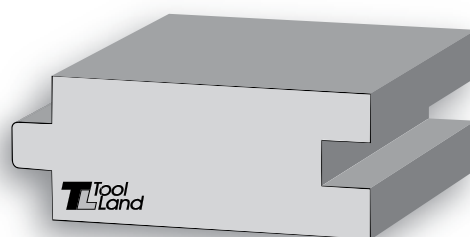

**M 1:2**

**ДП-4**



**M 1:5**

**ДП-5**

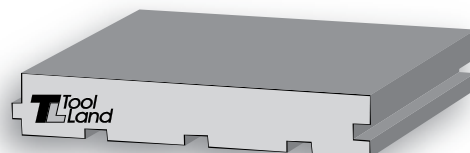

**M 1:2**

**ДП-6**

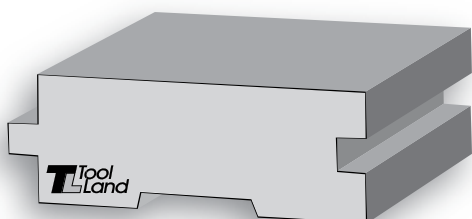

**M 1:2**

**ДП-7**

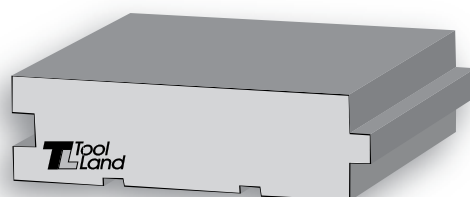

**M 1:2**

**ДП-8**

# НАЛИЧНИК

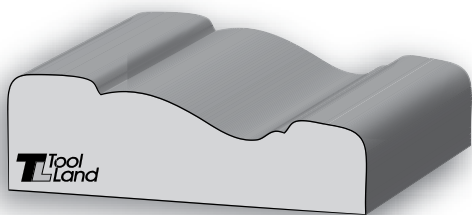

**M 1:1**

**H-1**

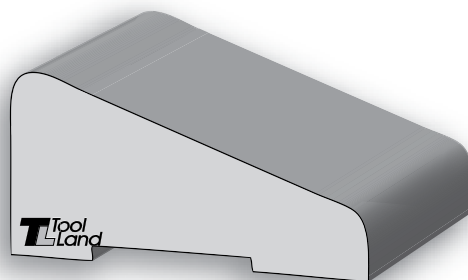

**M 1:1**

**H-2**

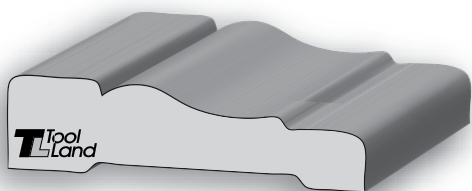

**M 1:1**

**H-3**

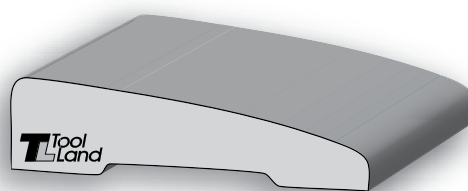

**M 1:1**

**H-4**

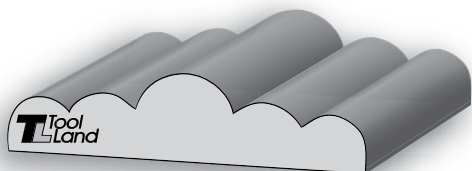

**M 1:1**

**H-5**

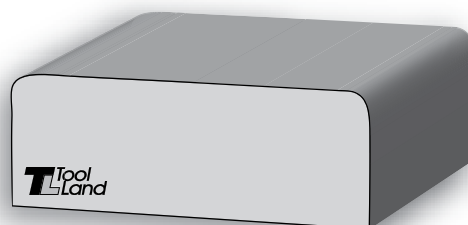

**M 1:1**

**H-6**

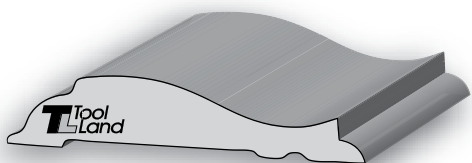

**M 1:1**

**H-7**

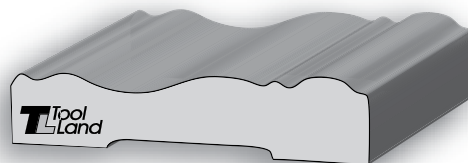

**M 1:1**

**H-8**

# НАЛИЧНИК

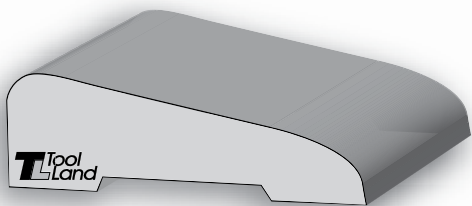

**M 1:1**

**H-9**

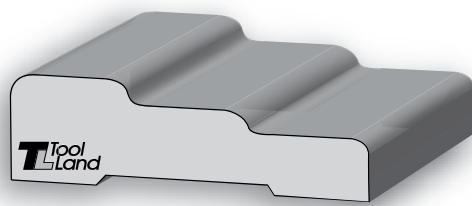

**M 1:1**

**H-10**

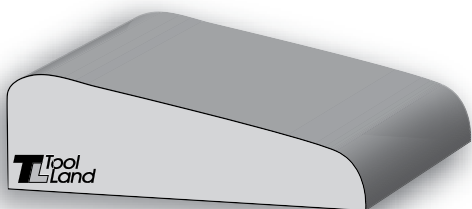

**M 1:1**

**H-11**

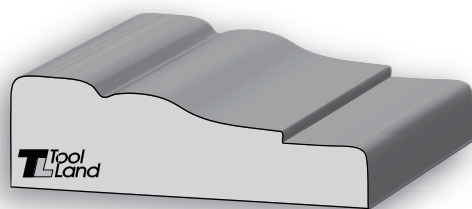

**M 1:1**

**H-12**

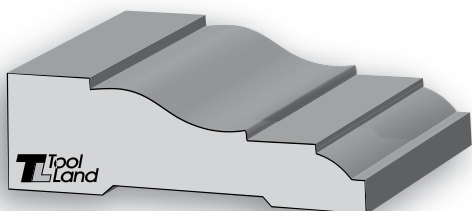

**M 1:1**

**H-13**

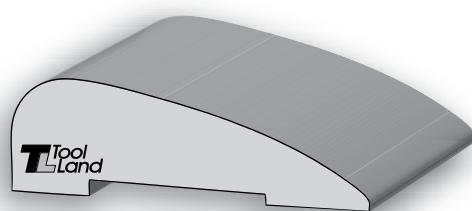

**M 1:1**

**H-14**

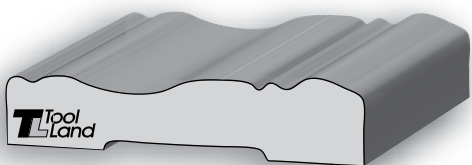

**M 1:1**

**H-15**

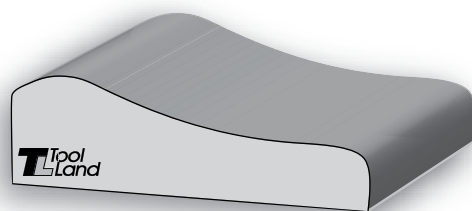

**M 1:1**

**H-16**

# НАЛИЧНИК

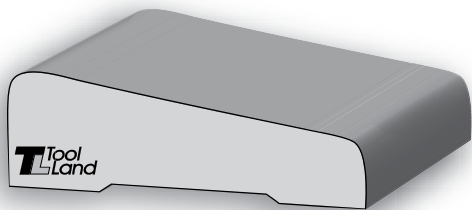

**M 1:1**

**H-17**

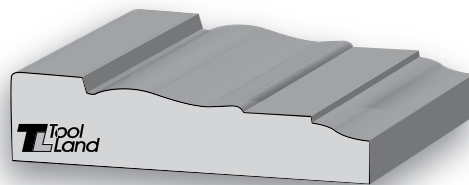

**M 1:1**

**H-18**

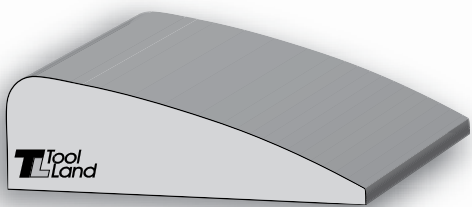

**M 1:1**

**H-19**

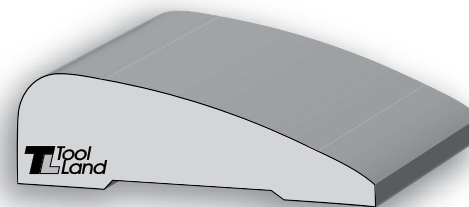

**M 1:1**

**H-20**

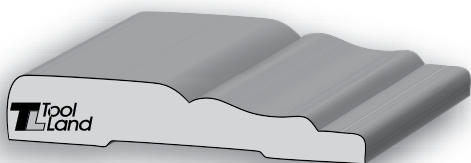

**M 1:1**

**H-21**

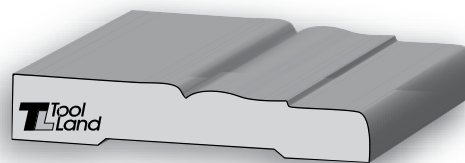

**M 1:1**

**H-22**

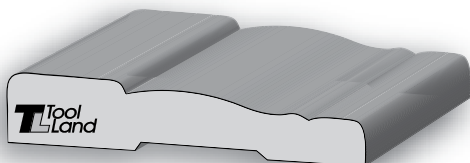

**M 1:1**

**H-23**

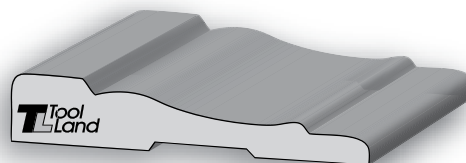

**M 1:1**

**H-24**

# НАЛИЧНИК

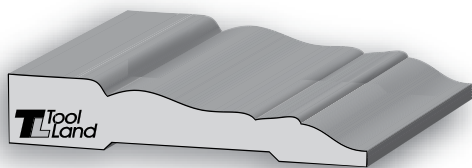

**M 1:1**

**H-25**

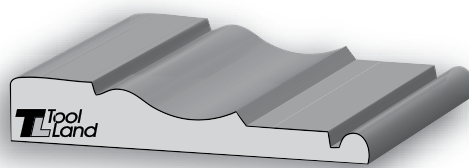

**M 1:1**

**H-26**

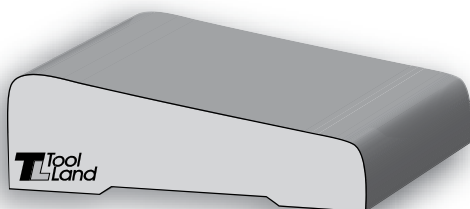

**M 1:1**

**H-27**

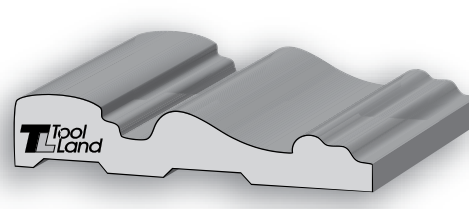

**M 1:1**

**H-28**

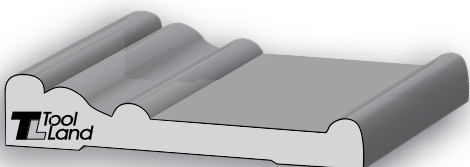

**M 1:1**

**H-29**

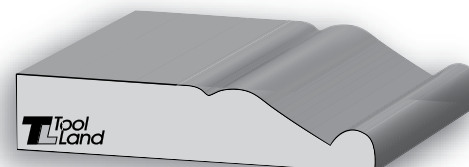

**M 1:1**

**H-30**

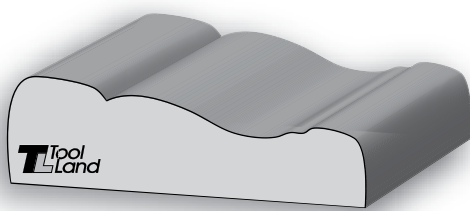

**M 1:1**

**H-31**

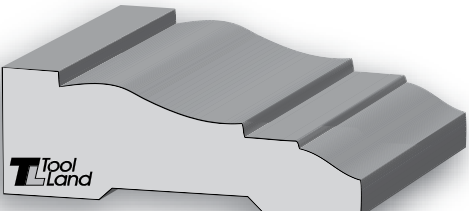

**M 1:1**

**H-32**

# ПЛИНТУС

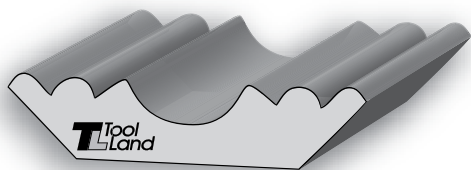

**M 1:1**

**П-1**

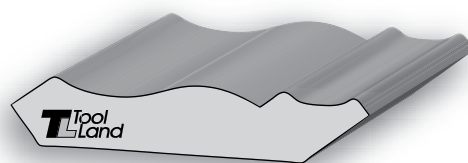

**M 1:1**

**П-2**

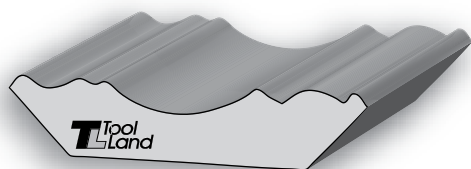

**M 1:1**

**П-3**



**M 1:1**

**П-4**

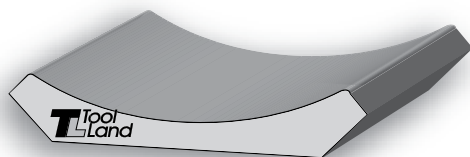

**M 1:1**

**П-5**



**M 1:1**

**П-6**

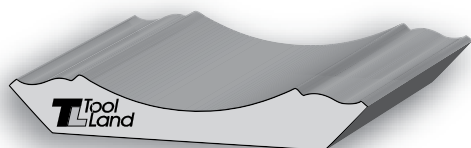

**M 1:1**

**П-7**



**M 1:1**

**П-8**



# ПЛИНТУС

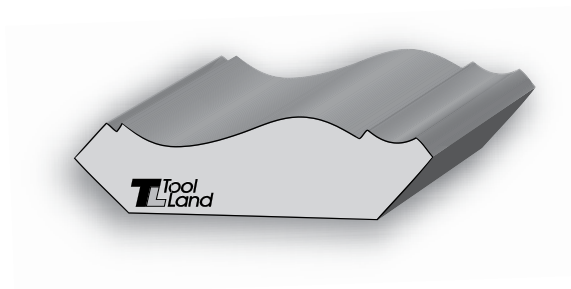

**M 1:1**

**П-17**

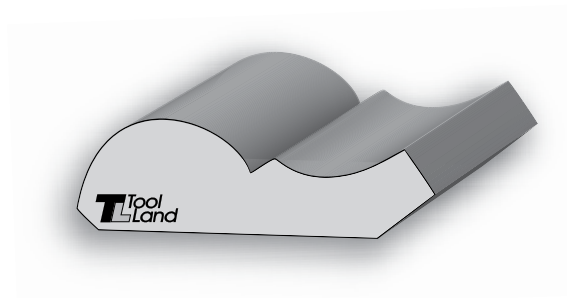

**M 1:1**

**П-18**

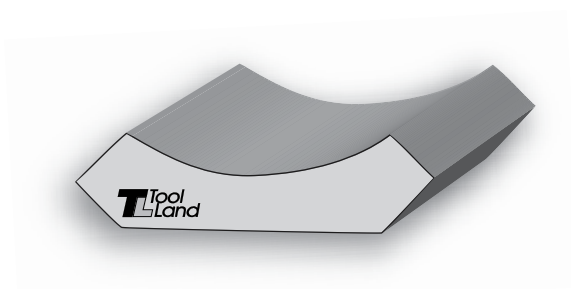

**M 1:1**

**П-19**

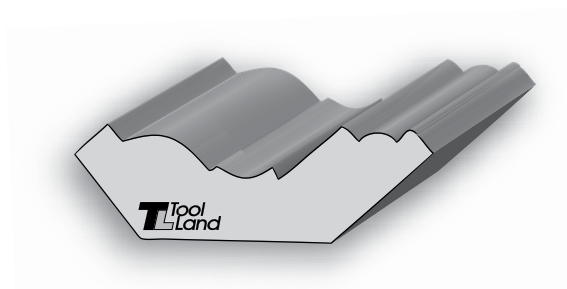

**M 1:1**

**П-20**

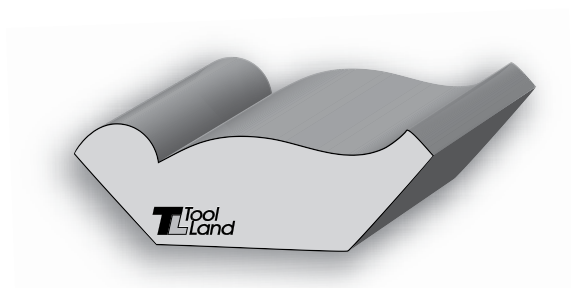

**M 1:1**

**П-21**

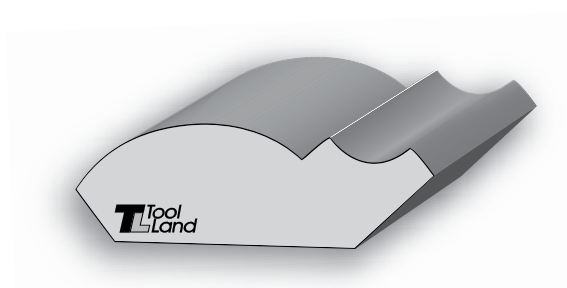

**M 1:1**

**П-22**

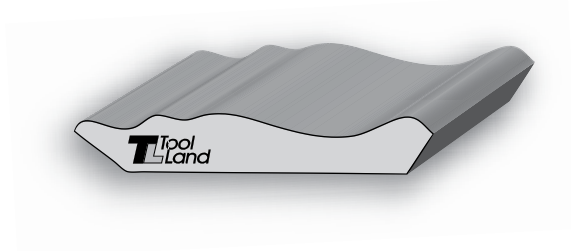

**M 1:1**

**П-23**

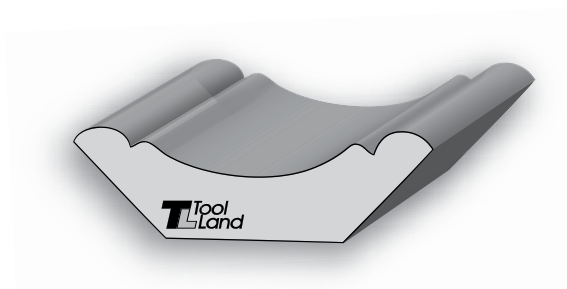

**M 1:1**

**П-24**

# ПЛИНТУС

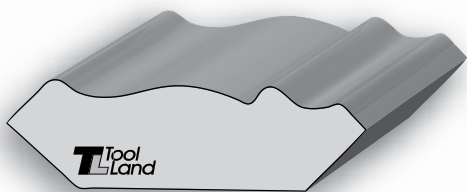

**M 1:1**

**П-25**

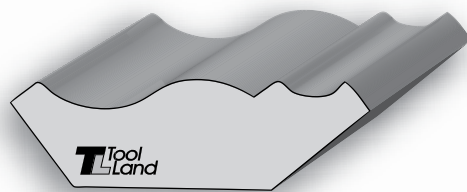

**M 1:1**

**П-26**

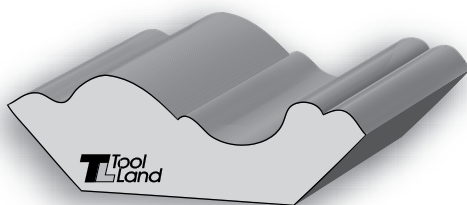

**M 1:1**

**П-27**

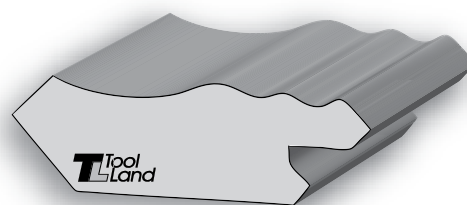

**M 1:1**

**П-28**

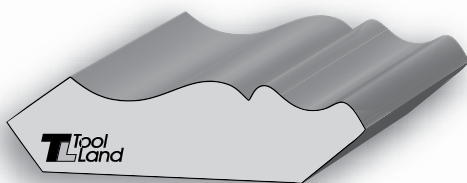

**M 1:1**

**П-29**

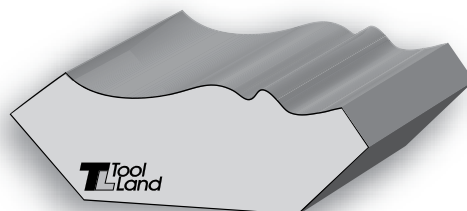

**M 1:1**

**П-30**

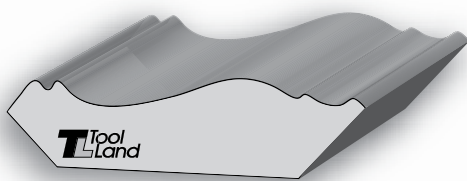

**M 1:1**

**П-31**



**M 1:1**

**П-32**

# ПЛИНТУС

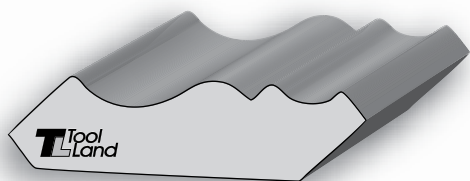

**M 1:1**

**П-33**

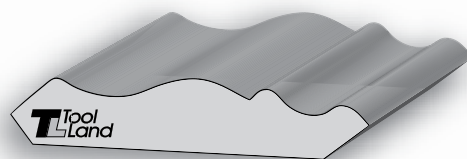

**M 1:1**

**П-34**

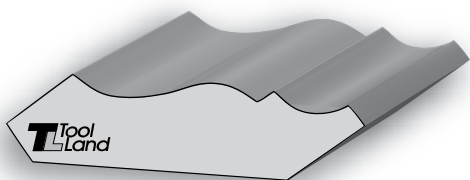

**M 1:1**

**П-35**

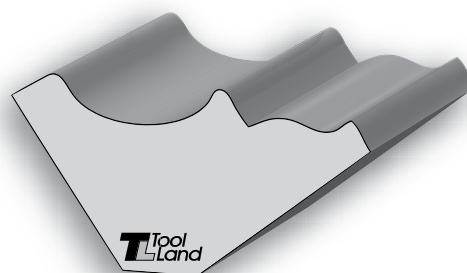

**M 1:1**

**П-36**

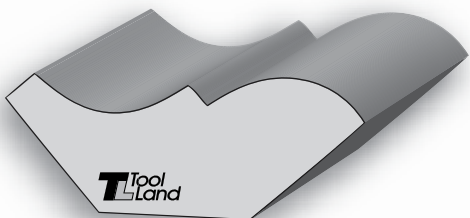

**M 1:1**

**П-37**

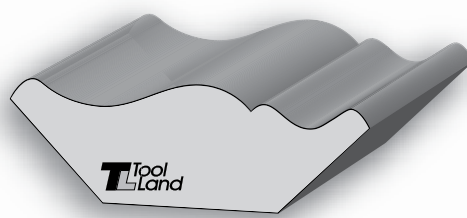

**M 1:1**

**П-38**

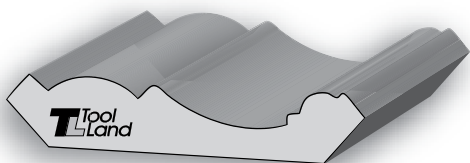

**M 1:1**

**П-39**

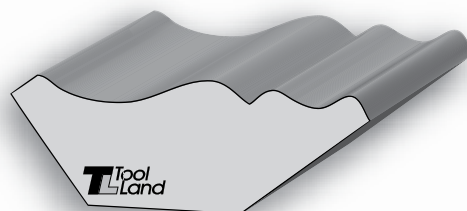

**M 1:1**

**П-40**

# ПЛИНТУС

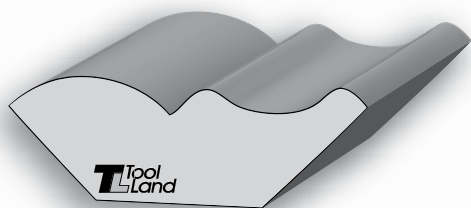

**М 1:1**

**П-41**

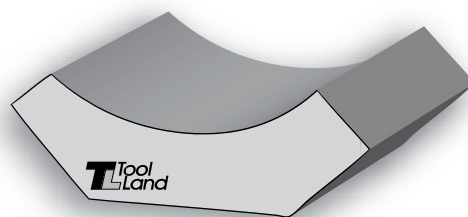

**М 1:1**

**П-42**

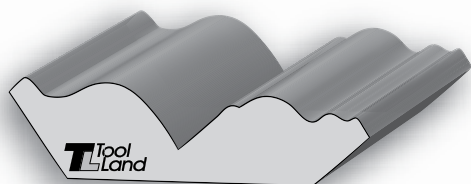

**М 1:1**

**П-43**

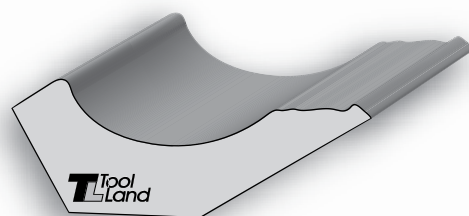

**М 1:1**

**П-44**

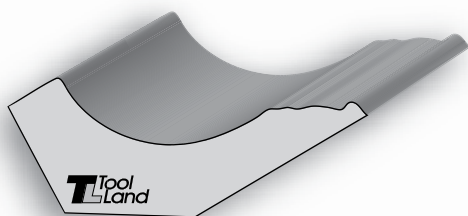

**М 1:1**

**П-45**

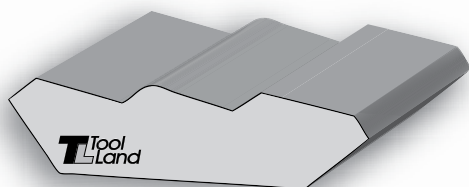

**М 1:1**

**П-46**

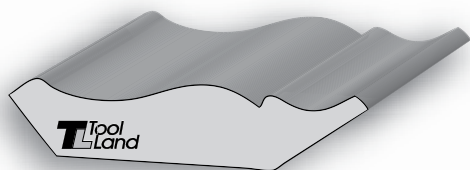

**М 1:1**

**П-47**

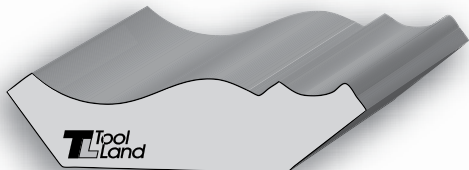

**М 1:1**

**П-48**

# ПЛИНТУС

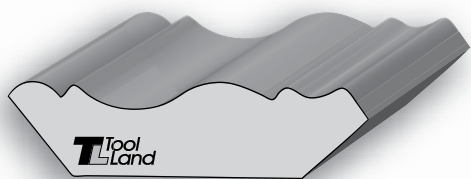

**M 1:1**

**П-49**

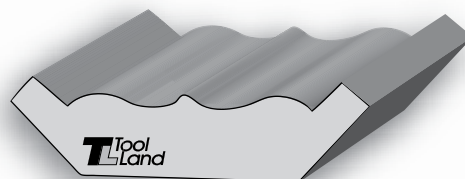

**M 1:1**

**П-50**

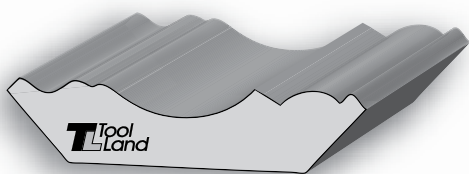

**M 1:1**

**П-51**

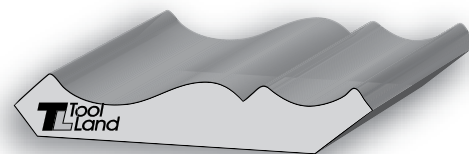

**M 1:1**

**П-52**

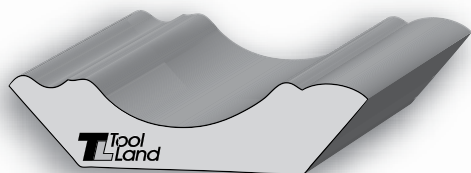

**M 1:1**

**П-53**

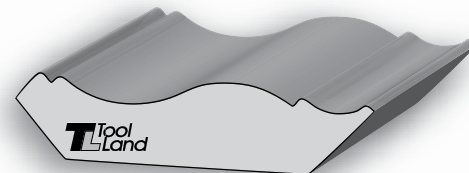

**M 1:1**

**П-54**

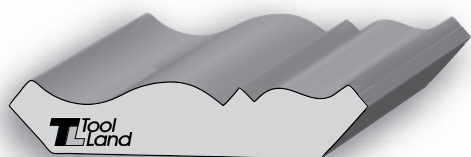

**M 1:1**

**П-55**

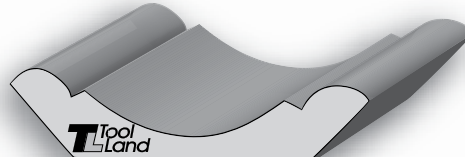

**M 1:1**

**П-56**

# ПЛИНТУС

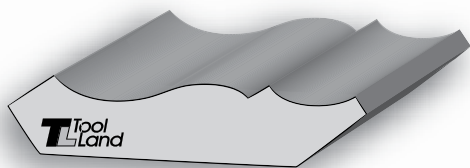

**M 1:1**

**П-57**

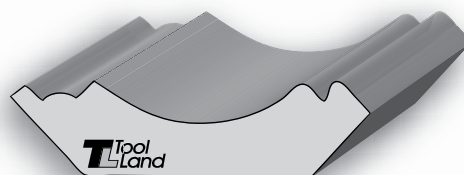

**M 1:1**

**П-58**

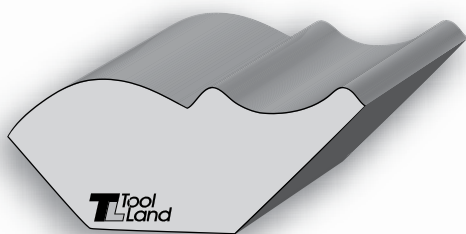

**M 1:1**

**П-59**

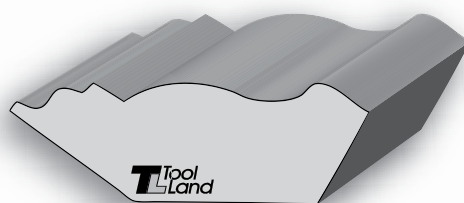

**M 1:1**

**П-60**



**M 1:1**

**П-61**



**M 1:1**

**П-62**

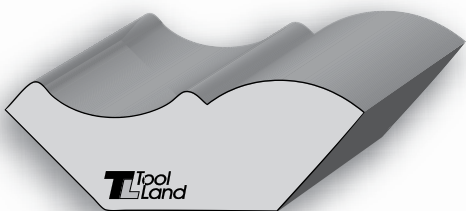

**M 1:1**

**П-63**

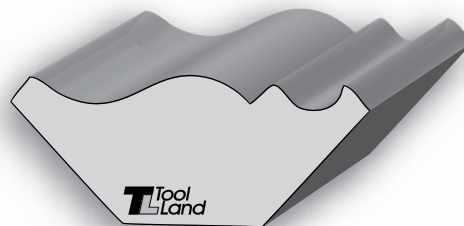

**M 1:1**

**П-64**

# КОРОБКА ДВЕРНАЯ

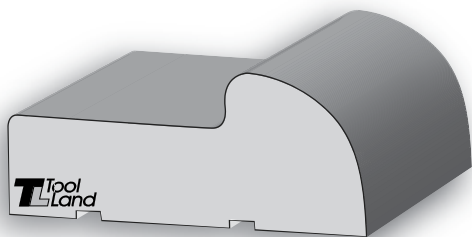

**M 1:1,5**

**K-1**

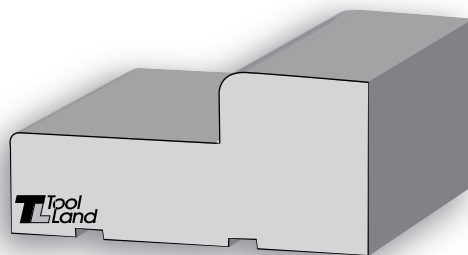

**M 1:1,5**

**K-2**

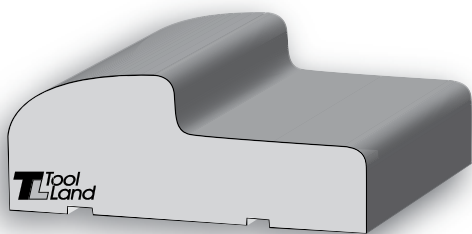

**M 1:1,5**

**K-3**

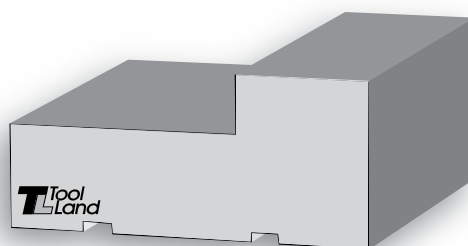

**M 1:1,5**

**K-4**

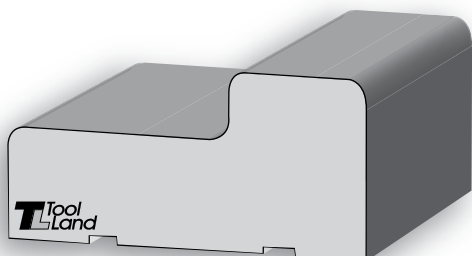

**M 1:1,5**

**K-5**

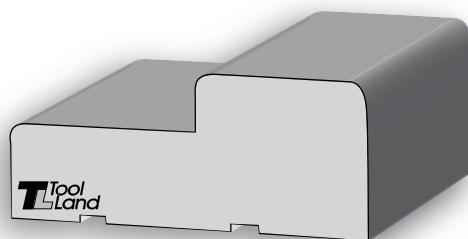

**M 1:1,5**

**K-6**

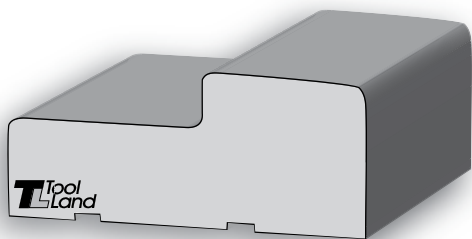

**M 1:1,5**

**K-7**

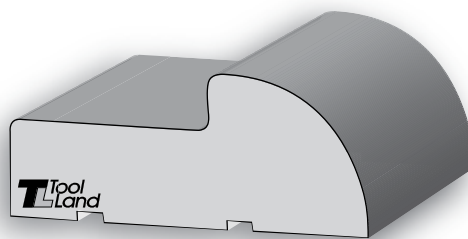

**M 1:1,5**

**K-8**

# ШТАПИКИ

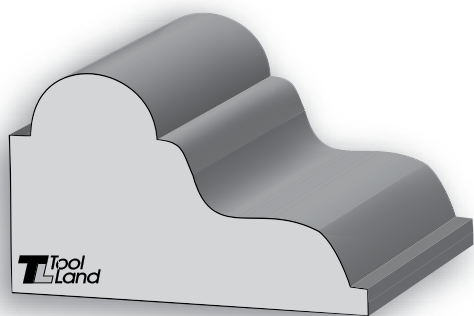

**M 2:1**

**Ш-1**

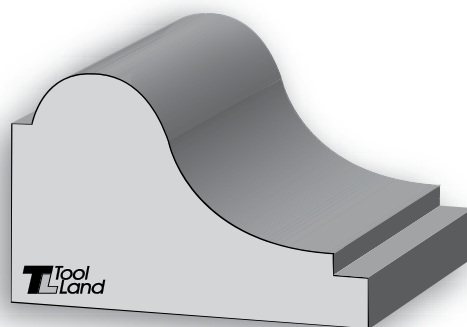

**M 2:1**

**Ш-2**

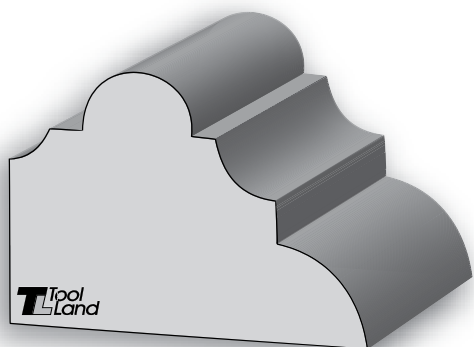

**M 2:1**

**Ш-3**

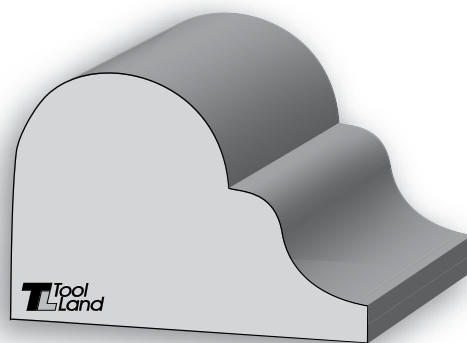

**M 2:1**

**Ш-4**

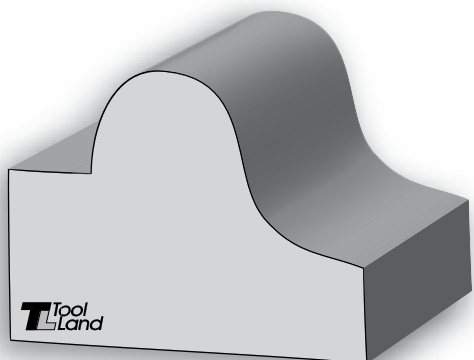

**M 2:1**

**Ш-5**

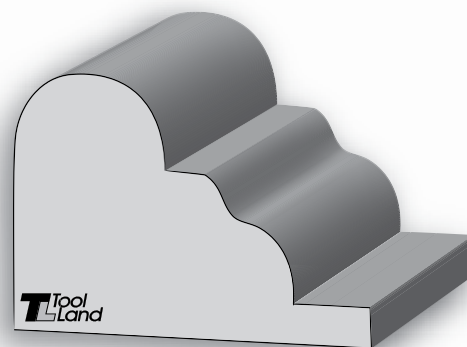

**M 2:1**

**Ш-6**

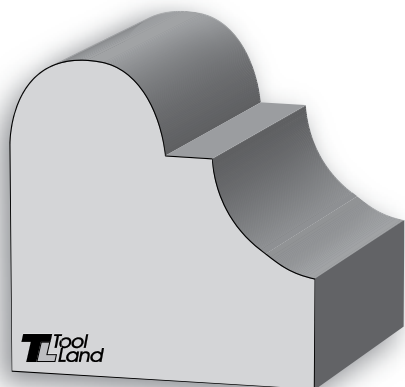

**M 2:1**

**Ш-7**

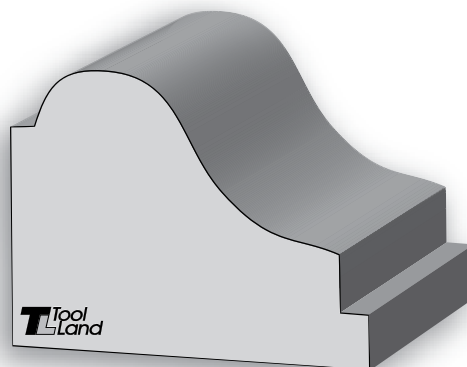

**M 2:1**

**Ш-8**



# ШТАПИКИ

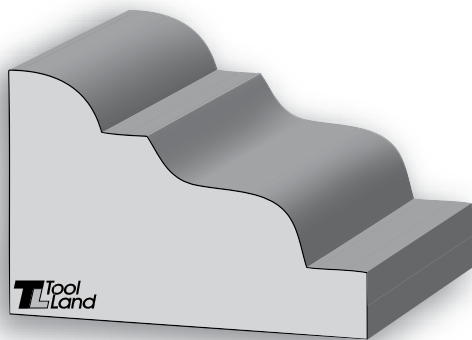

**M 2:1**

**Ш-9**

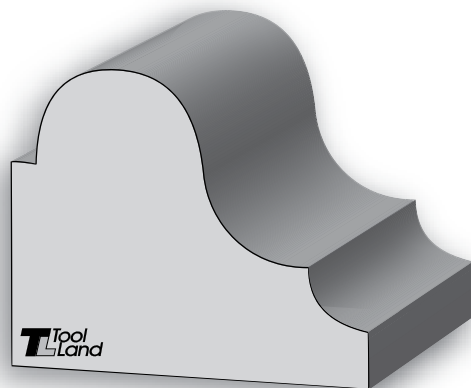

**M 2:1**

**Ш-10**

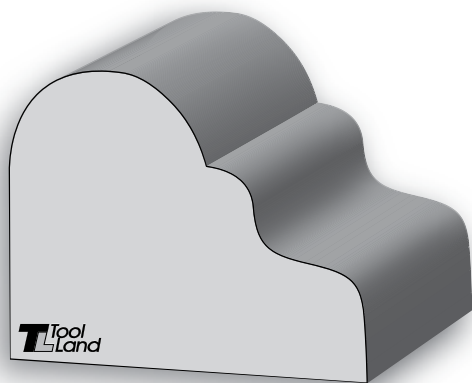

**M 2:1**

**Ш-11**

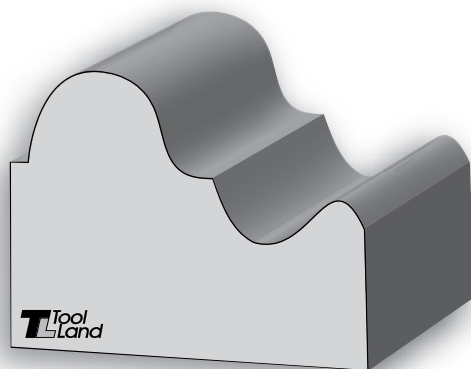

**M 2:1**

**Ш-12**

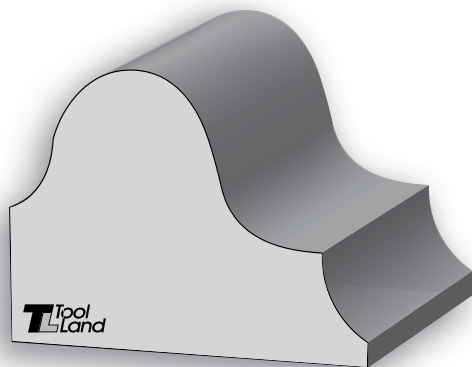

**M 2:1**

**Ш-13**

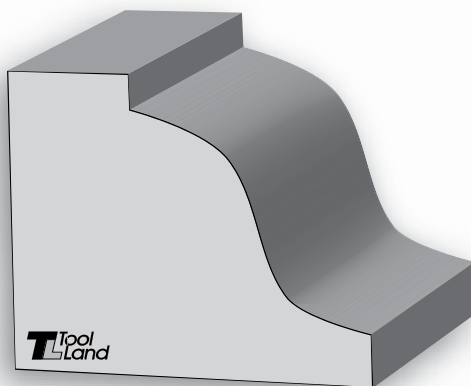

**M 2:1**

**Ш-14**

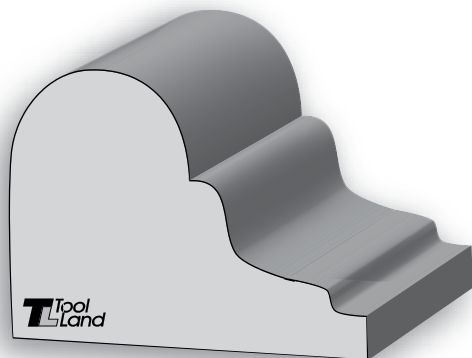

**M 2:1**

**Ш-15**

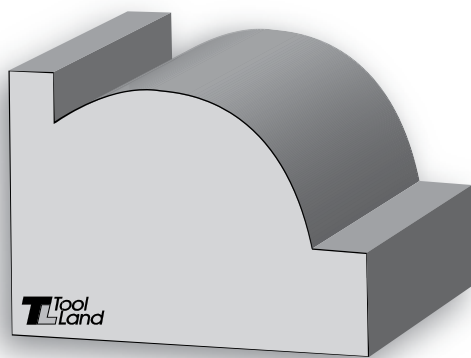

**M 2:1**

**Ш-16**

# КАРНИЗ

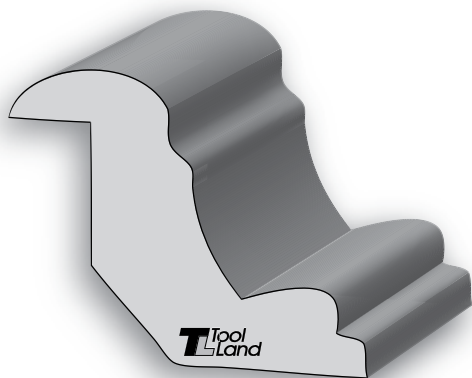

**M 2:1**                      **K-1**

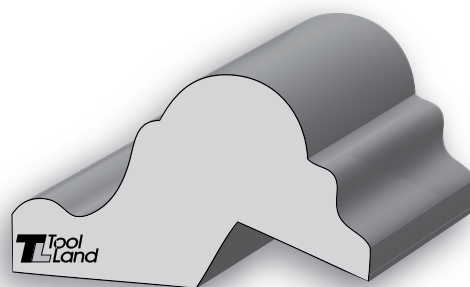

**M 2:1**                      **K-2**

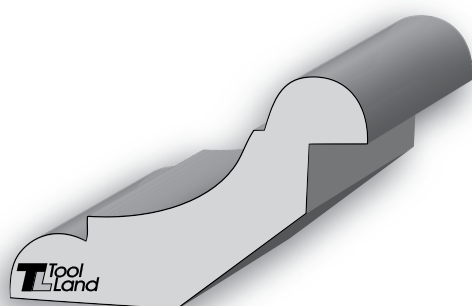

**M 2:1**                      **K-3**

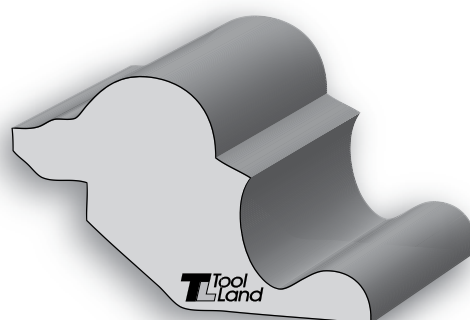

**M 2:1**                      **K-4**

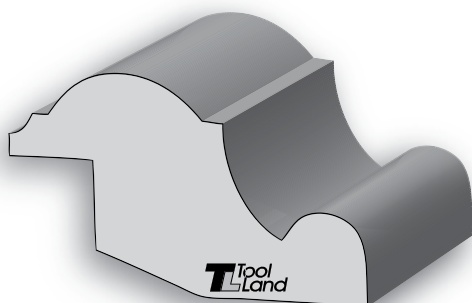

**M 2:1**                      **K-5**

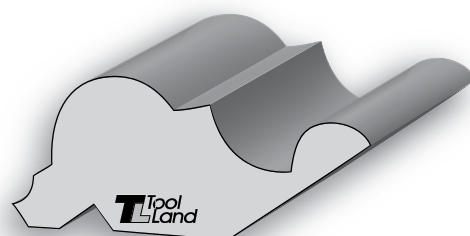

**M 2:1**                      **K-6**

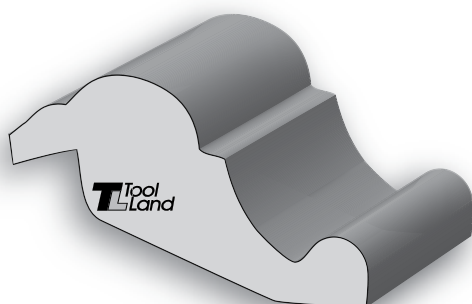

**M 2:1**                      **K-7**

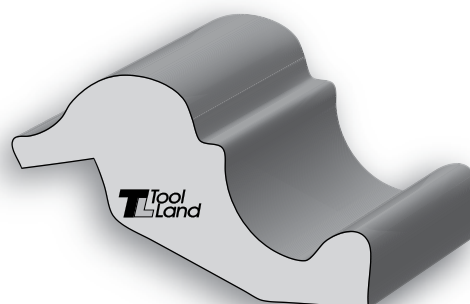

**M 2:1**                      **K-8**

# ПОРУЧЕНЬ

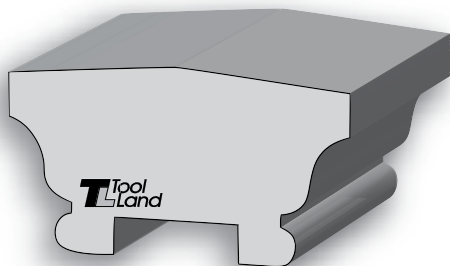

**M 1:2**

**П-1**



**M 1:2**

**П-2**



**M 1:2**

**П-3**

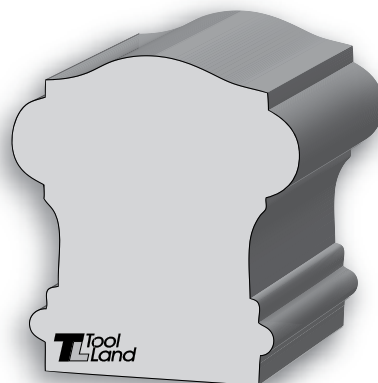

**M 1:2**

**П-4**

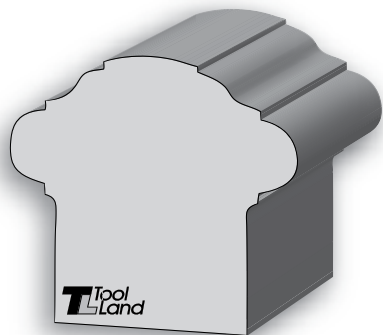

**M 1:2**

**П-5**

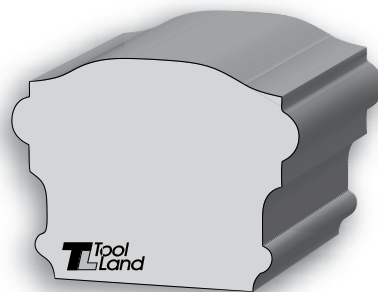

**M 1:2**

**П-6**

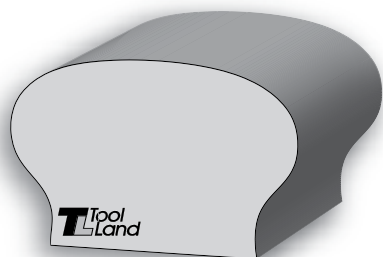

**M 1:2**

**П-7**

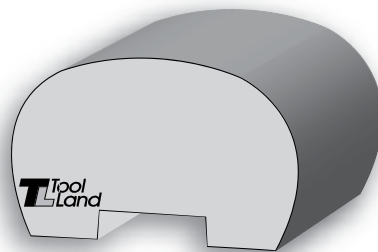

**M 1:2**

**П-8**

# УГОЛОК

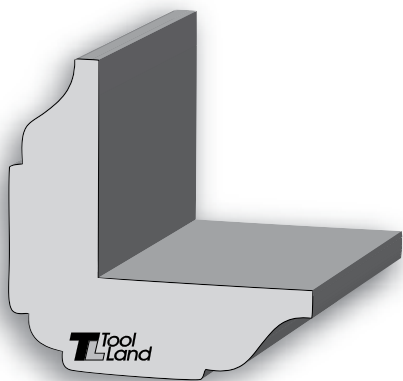

**M 1:1**

**У-1**

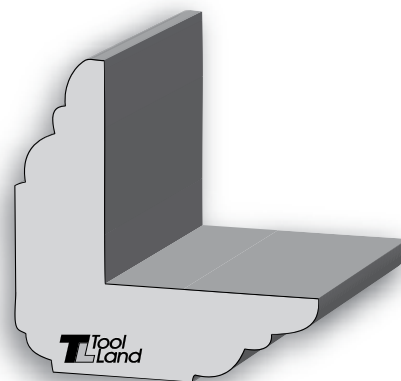

**M 1:1**

**У-2**

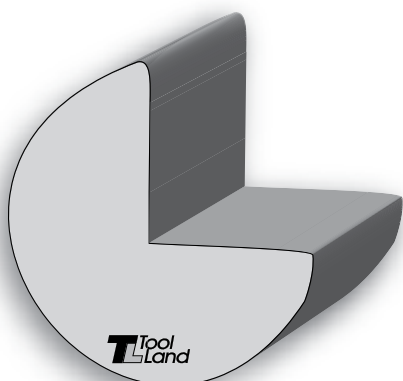

**M 1:1**

**У-3**

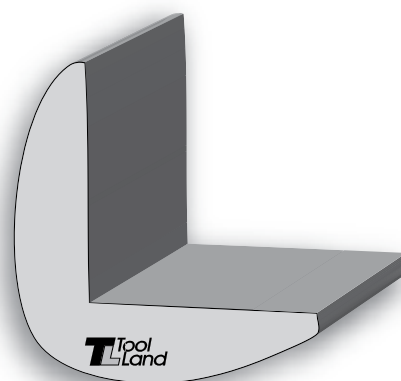

**M 1:1**

**У-4**

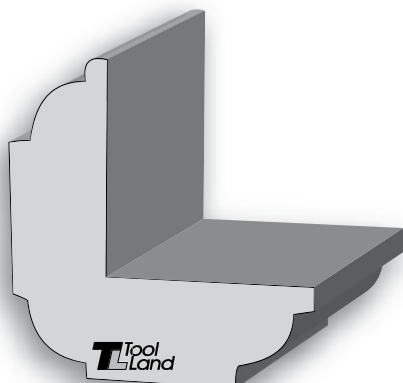

**M 1:1**

**У-5**

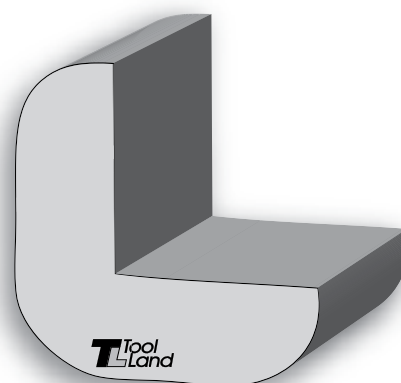

**M 1:1**

**У-6**

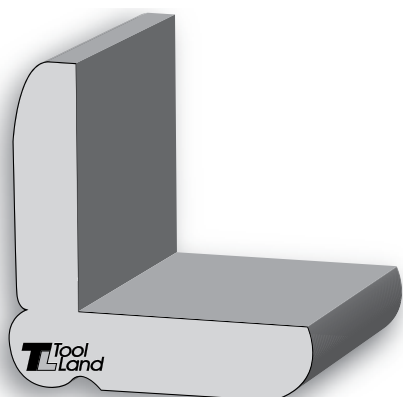

**M 1:1**

**У-7**

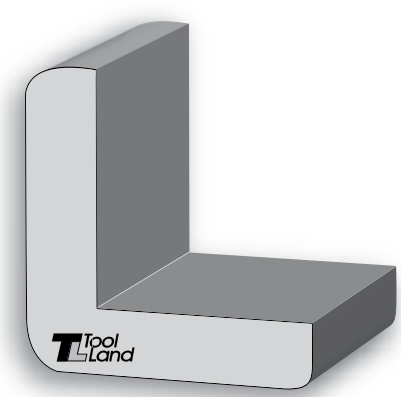

**M 1:1**

**У-8**

# БЛОК ХАУЗ

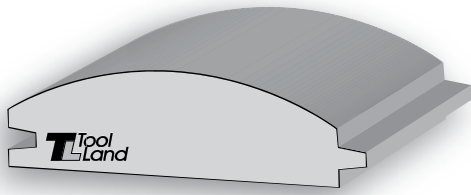

**M 1:2**

**БХ-1**

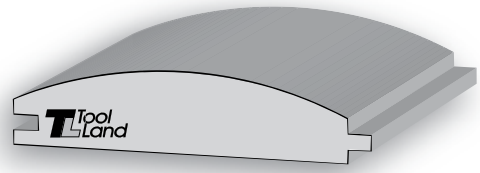

**M 1:2**

**БХ-2**

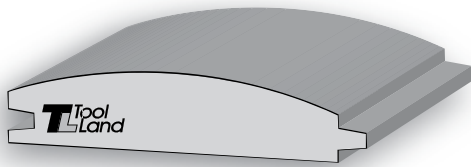

**M 1:2**

**БХ-3**

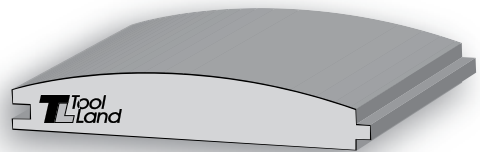

**M 1:2**

**БХ-4**

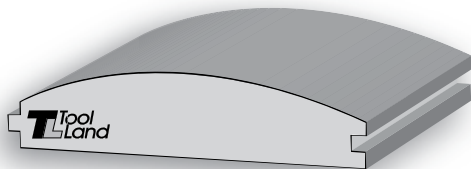

**M 1:2**

**БХ-5**

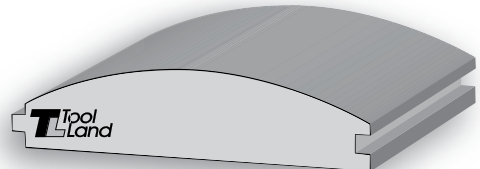

**M 1:2**

**БХ-6**

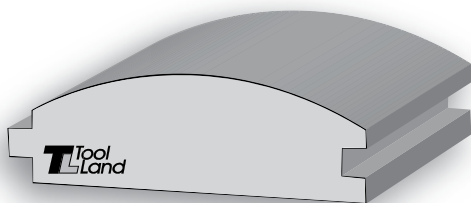

**M 1:2**

**БХ-7**

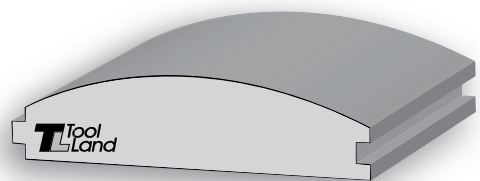

**M 1:2**

**БХ-8**

# КОНСТРУКЦИОННЫЙ БРУС

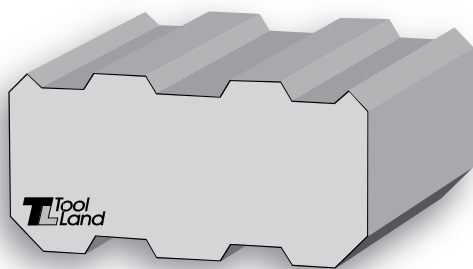

**M 1:5**

**KB-1**

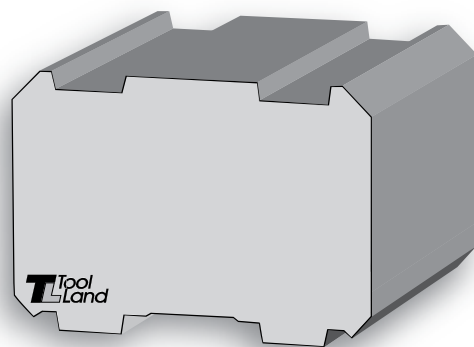

**M 1:5**

**KB-2**

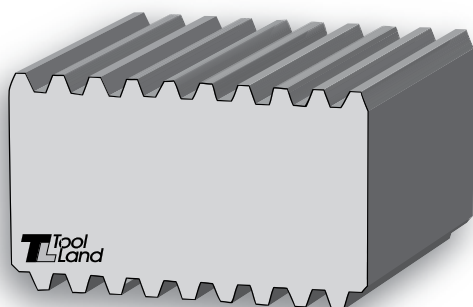

**M 1:5**

**KB-3**

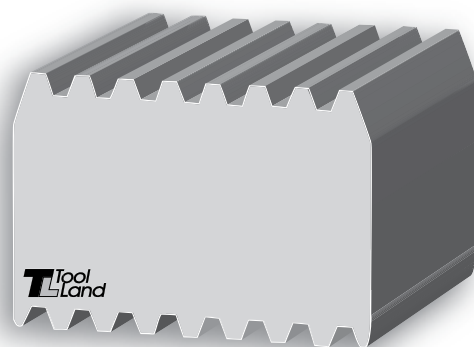

**M 1:5**

**KB-4**

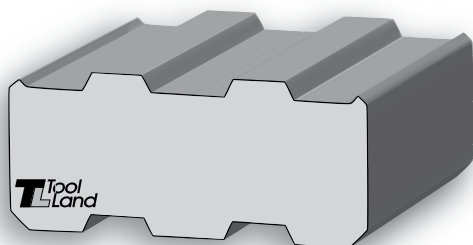

**M 1:5**

**KB-5**

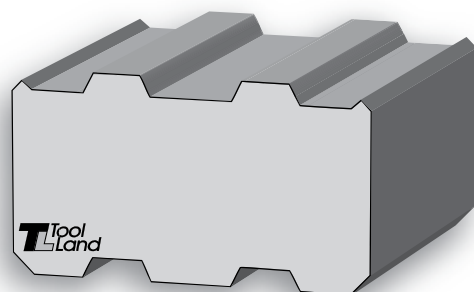

**M 1:5**

**KB-6**

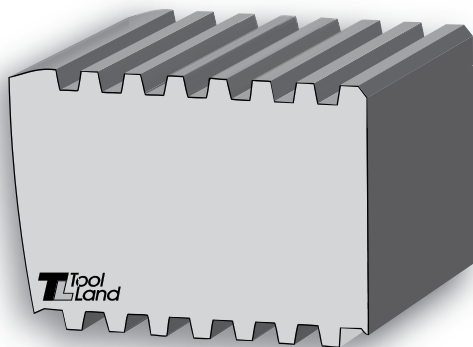

**M 1:5**

**KB-7**

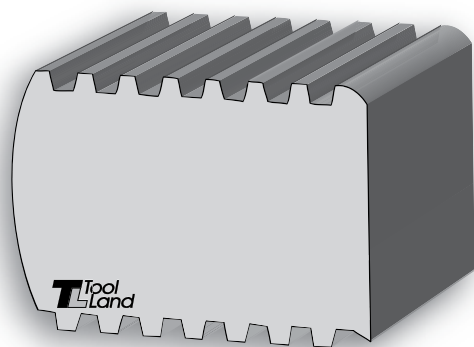

**M 1:5**

**KB-8**

# КОНСТРУКЦИОННЫЙ БРУС

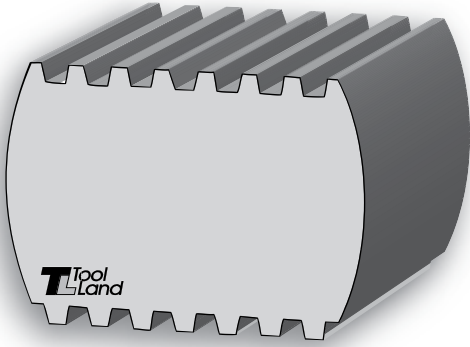

**M 1:5**

**KB-9**

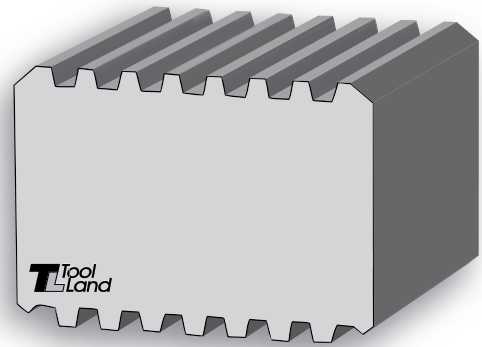

**M 1:5**

**KB-10**

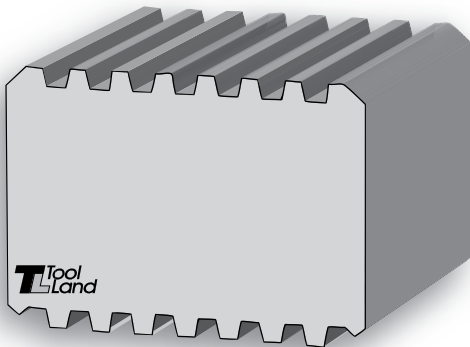

**M 1:5**

**KB-11**

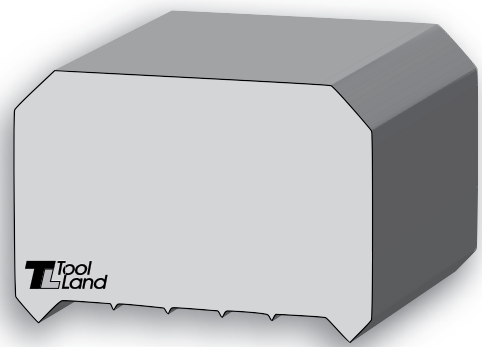

**M 1:5**

**KB-12**

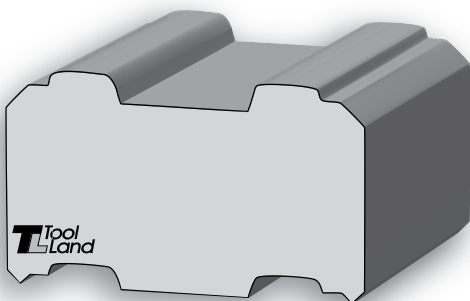

**M 1:5**

**KB-13**

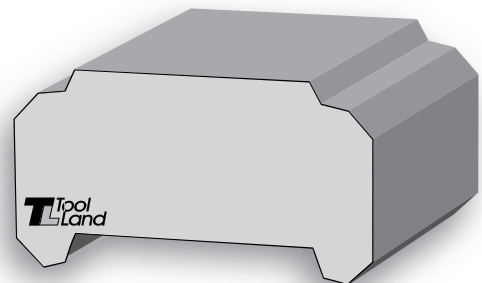

**M 1:5**

**KB-14**

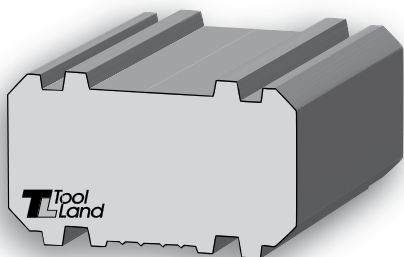

**M 1:5**

**KB-15**

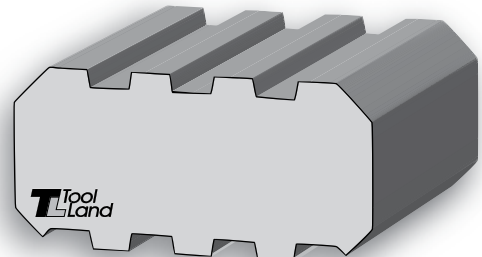

**M 1:5**

**KB-16**

# ■ ОБЛИЦОВОЧНАЯ ЦИЛИНДРИЧЕСКАЯ ПОВЕРХНОСТЬ ■

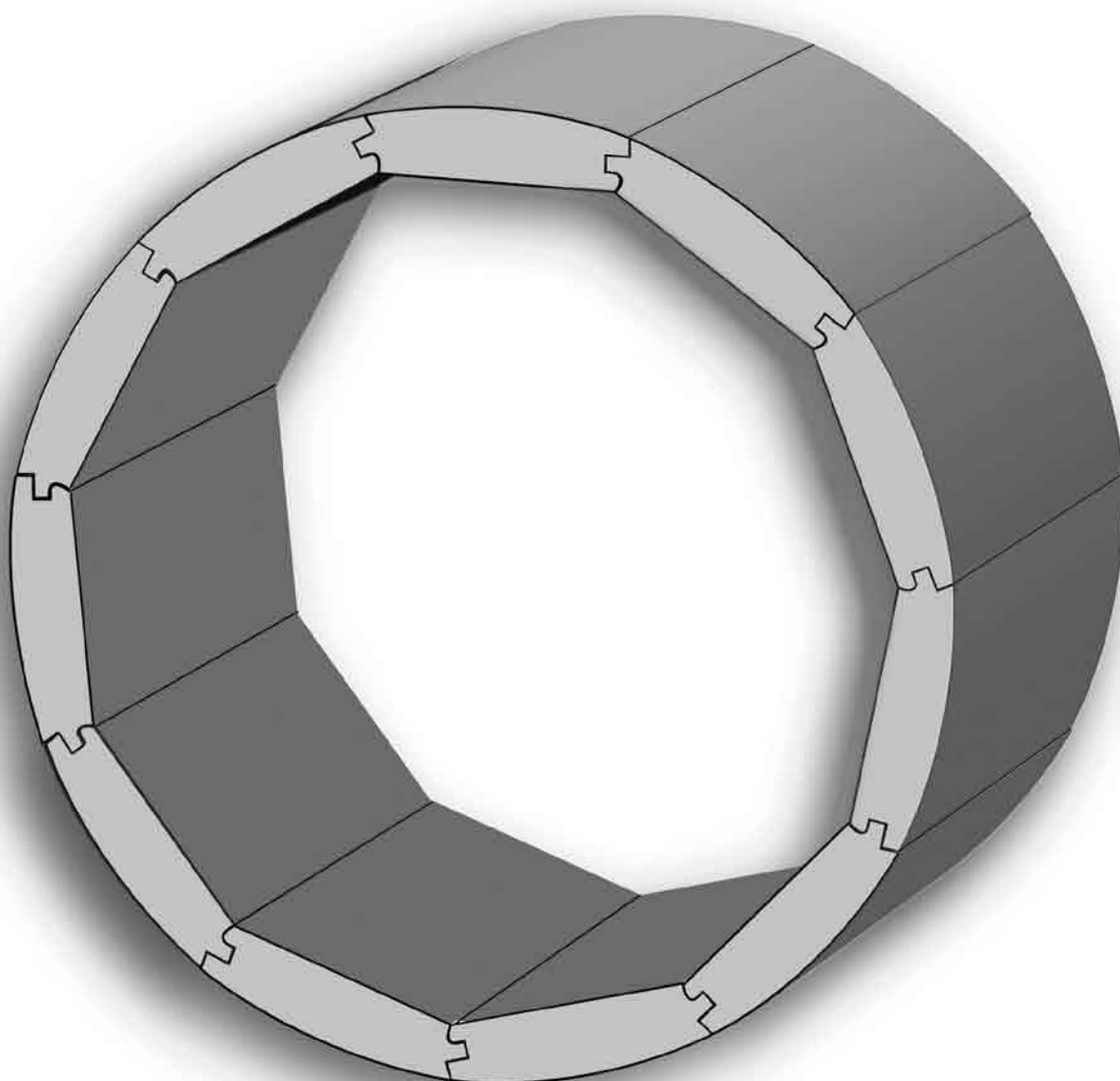
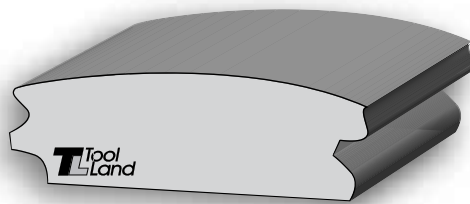



# ■ ОБЛИЦОВОЧНАЯ ЦИЛИНДРИЧЕСКАЯ ПОВЕРХНОСТЬ ■

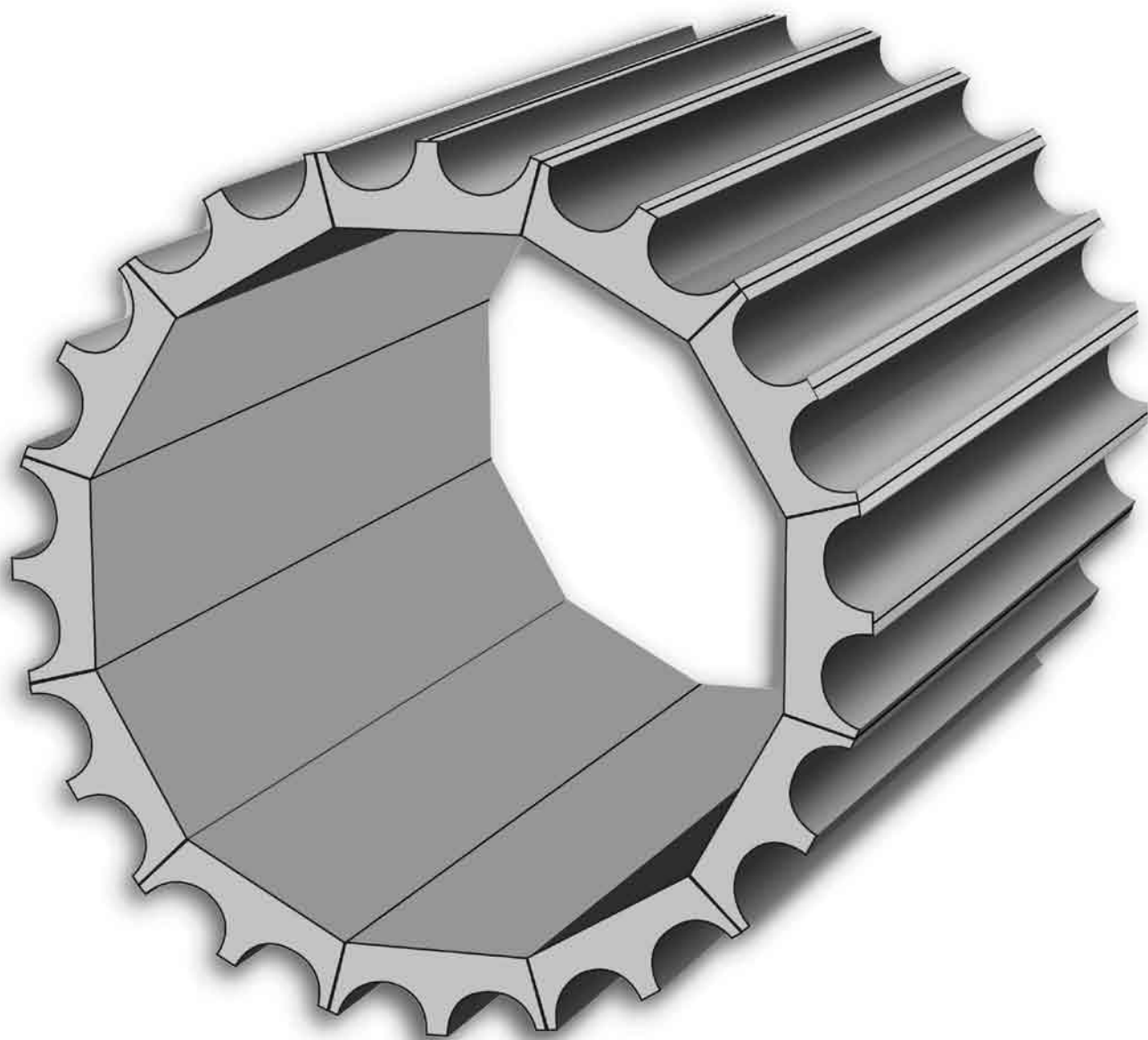
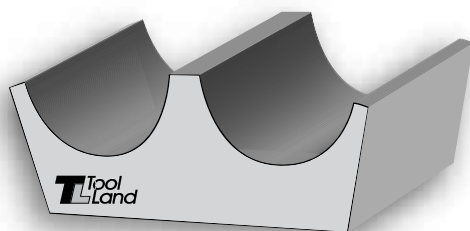

# ■ ОБЛИЦОВОЧНАЯ ЦИЛИНДРИЧЕСКАЯ ПОВЕРХНОСТЬ ■

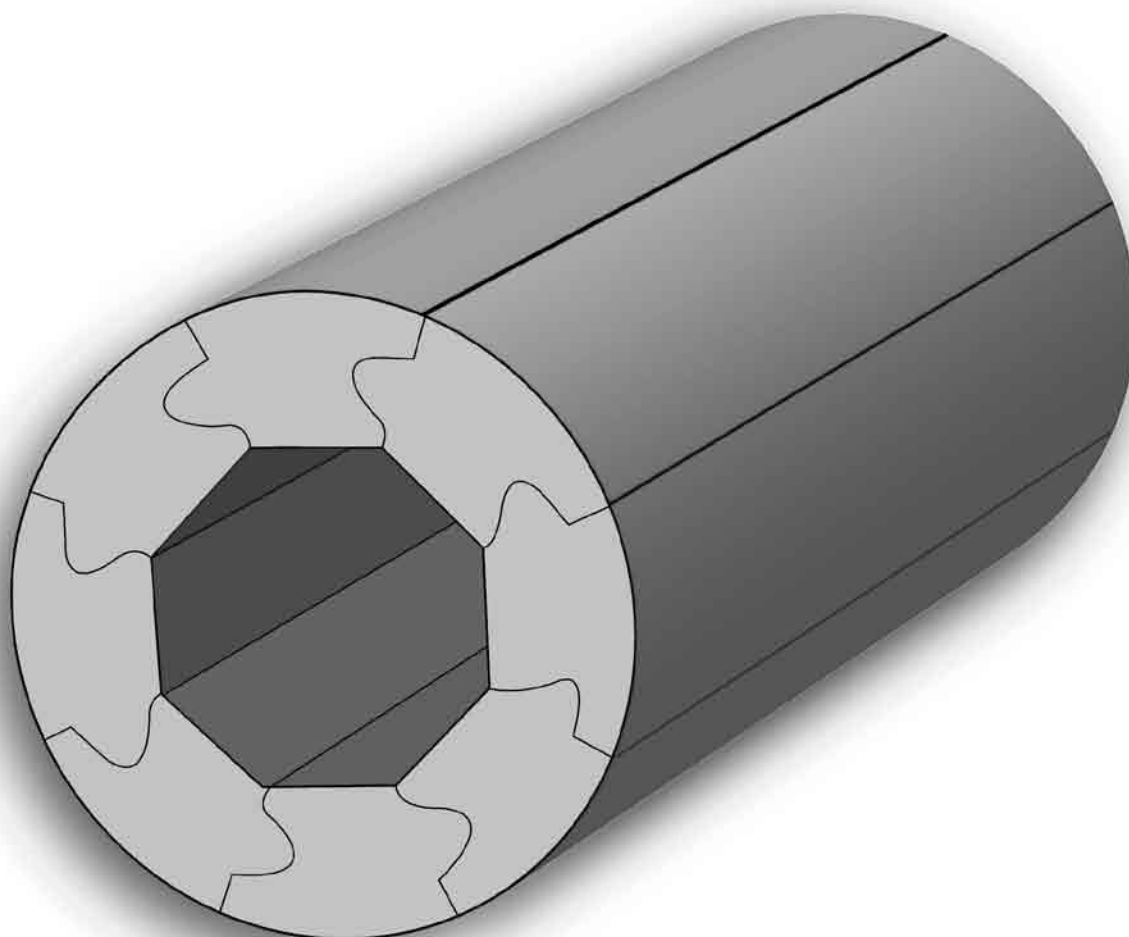

# ТЕРРАСНЫЕ ДОСКИ

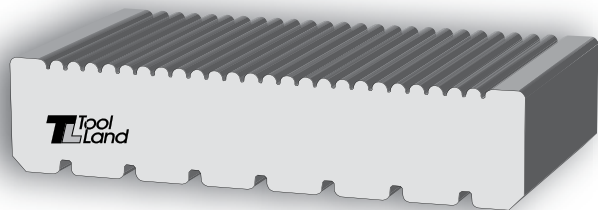

**TD 1**

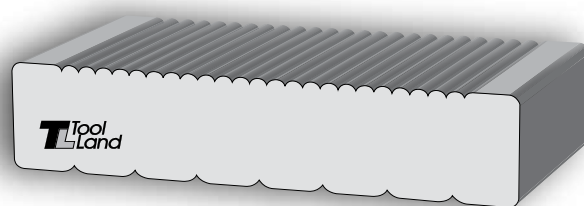

**TD 2**

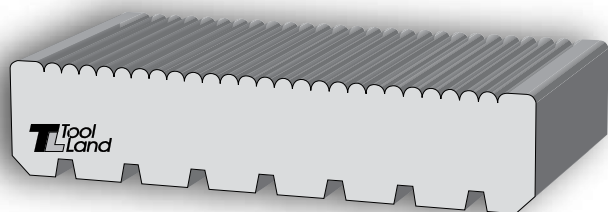

**TD 3**

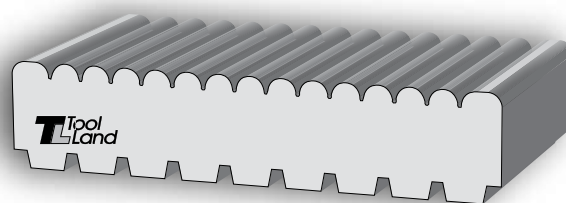

**TD 4**

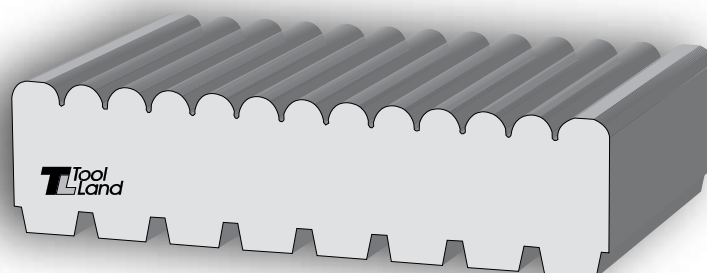

**TD 5**

## ПОТОЛОЧНЫЕ БАЛКИ ДЛЯ ОПАЛУБКИ

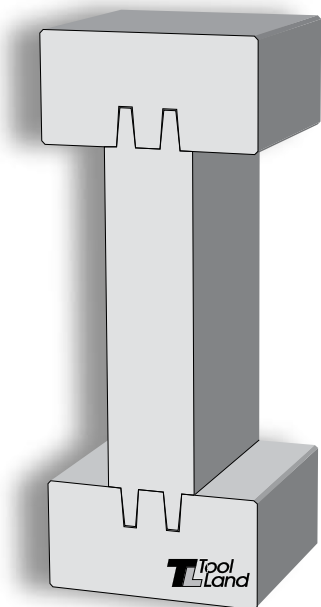

**PB 1**

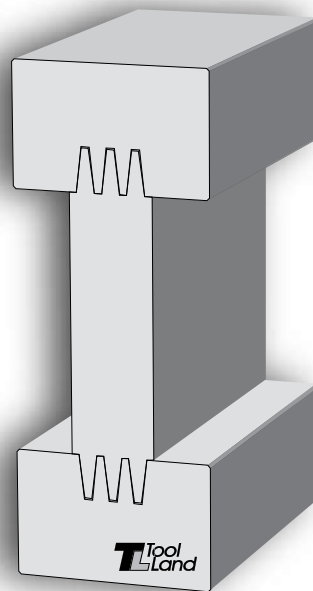

**PB 2**

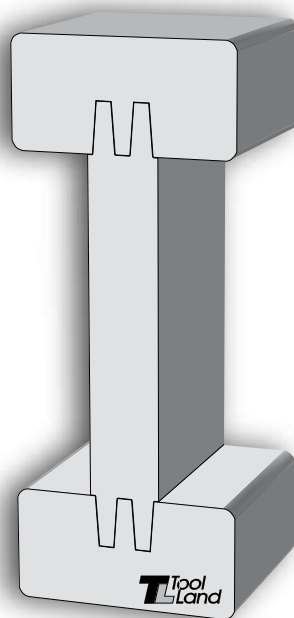

**PB 3**